

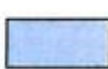

T- Hangar Diagrams

Northeast T-Hangars

FY 2027

 = \$636.06

 = \$725.11

 = \$865.04

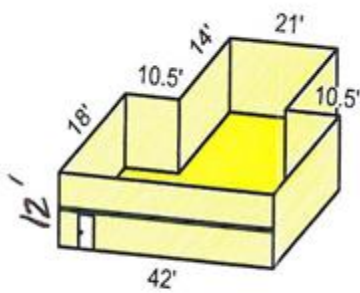

BAY 1 - 7

Approx. 1,050 sq. ft.

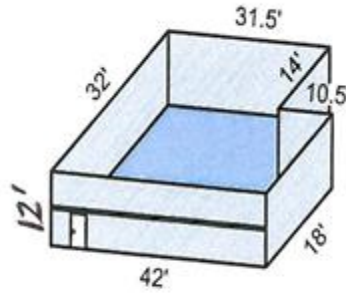

BAY 8

Approx. 1,197 sq. ft

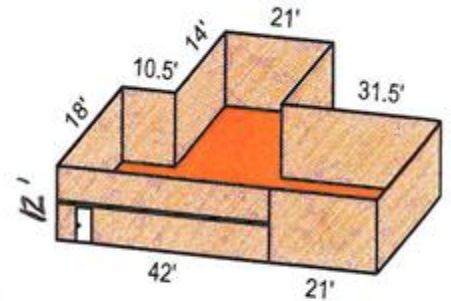

BAY 2X

Approx. 1,428 sq. ft.

Northeast T-hangar

Approximate door opening height: 11'8"

**Prices may adjust May 1st.*

T- Hangar Diagrams
Southwest T-Hangars
FY 2027

SW Building 50

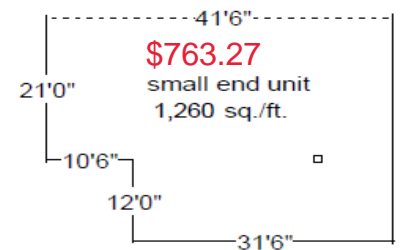
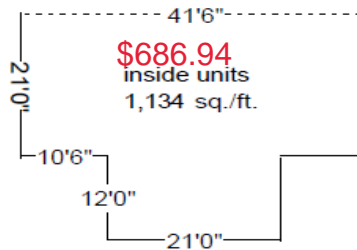
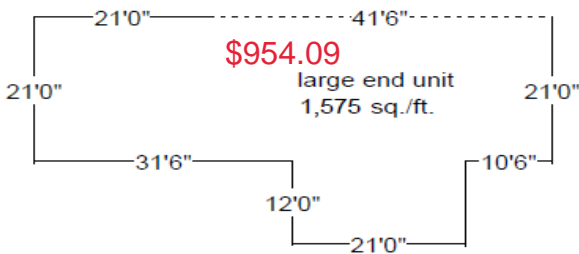

SW Building 51

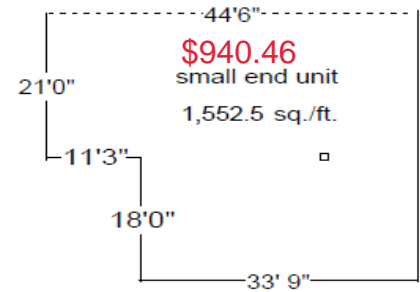
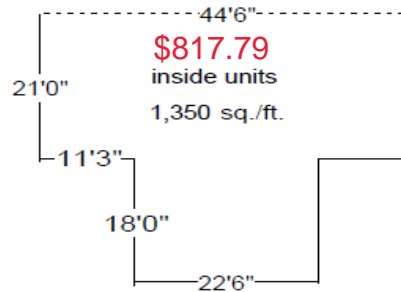
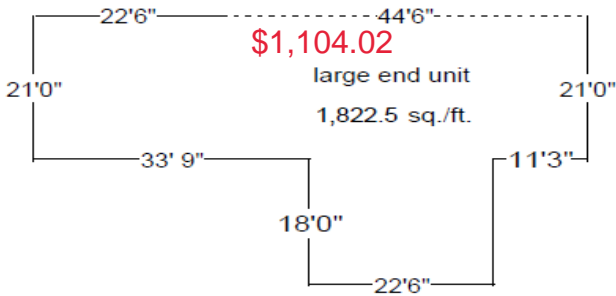

SW 50

Large End Unit (50-2) = \$954.09
Inside Units (50-3 thru 50-10) = \$686.94
Small End Unit (50-1) = \$763.27
 Approximate door opening height: 11' 4"

SW 51

Large End Unit (51-2 & 51-9) = \$1,104.02
Inside Units (51-1, 51-3, thru 51-8) = \$817.79
Small End Unit (51-10) = \$940.46

Approximate door opening height: 13' 5"

*Prices may adjust May 1st.