



T- Hangar Diagrams

Northeast T-Hangars

	=	\$617.04
	=	\$703.43
	=	\$839.17

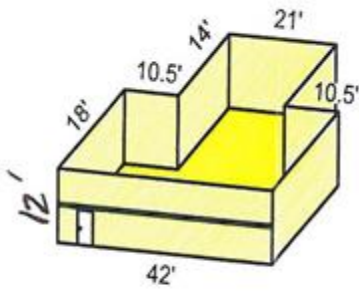

BAY 1 - 7

Approx. 1,050 sq. ft.

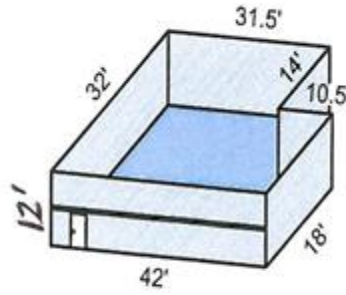

BAY 8

Approx. 1,197 sq. ft

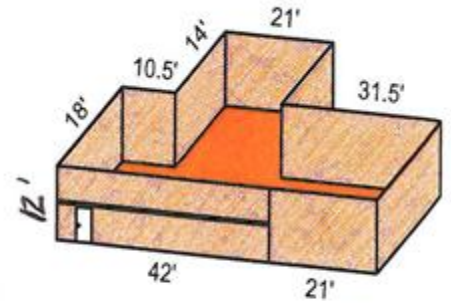

BAY 2X

Approx. 1,428 sq. ft.

Northeast T-hangar

Approximate door opening height: 11'8"

**Prices will adjust May 1st.*

T- Hangar Diagrams Southwest T-Hangars

N54-42

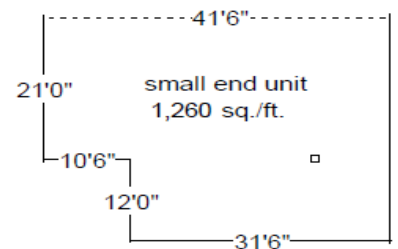
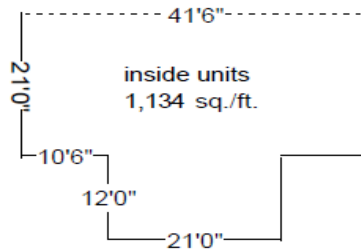
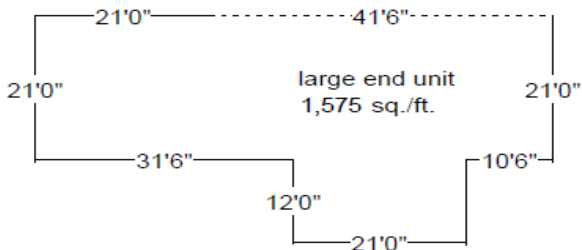

N60-45

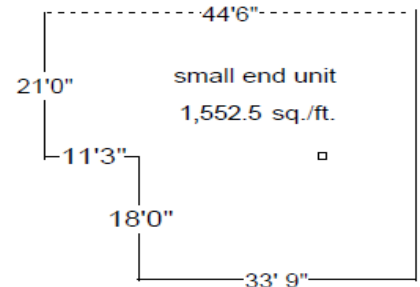
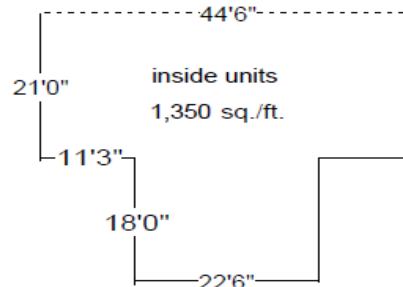
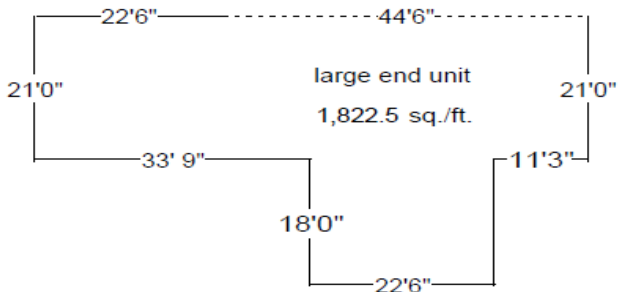

N54-42 (TH50)

Large End Unit (50-2) = \$925.56

Inside Units (50-3 through 50-10) = \$666.40

Small End Unit (50-1) = \$740.45

Approximate door opening height: 11' 4"

N60-45 (TH51)

Large End Unit (51-9) = \$1,071.01

Inside Units (51-1 through 51-8) = \$793.34

Small End Unit (51-10) = \$912.34

Approximate door opening height: 13' 5"

**Prices will adjust May 1st.*